

SAFETY COVER SYSTEMS

INSTALLATION & MAINTENANCE INSTRUCTIONS FOR RECTANGULAR AND CUSTOM COVERS

IMPORTANT: Do not drag cover on pool deck or any rough surface. Dragging cover on rough surface will cause scuffing, abrasions and/or holes. Damage due to dragging cover on rough surface is specifically excluded from cover warranty.

INSTALLING A RECTANGULAR COVER

PLEASE NOTE: If a cover is going to be anchored into a raised bond beam, spa wall, waterfall, etc., proceed to the instructions on the top of the reverse side.

STEP 1

Inspect the area 3' back from the water's edge around the entire pool. Remove any irregular obstructions that may protrude through the cover. Pad rough coping, sharp edges, and inside corners with carpet, foam or similar material. Excessive wear due to non-padded areas is specifically excluded from the warranty.

STEP 2

Measure exact dimensions of swimming pool and cover. From the difference between these measurements, adjust the overlap so that it is equal at all corners of the pool. Though standard overlaps on stock covers are 12" and custom covers 15"-18", they may vary several inches either way.

STEP 3

Measure 22" from corner in each direction and locate position point (A) of anchors for all four corners.

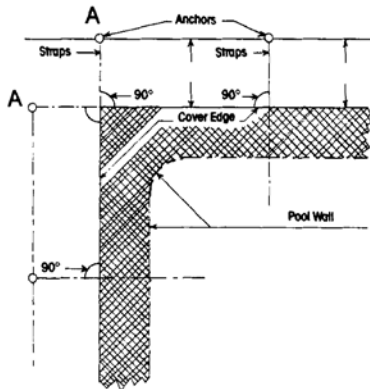

STEP 4

Install the 8 anchors at the 4 corners and step section if applicable. (see Anchor Installation on reverse side). Attach flat shaped side of springs to corner straps (see spring attached to cover for proper spring attachment). Next, install the springs on anchors using the Installation Rod (see Cover Installation on reverse side). Adjust buckles so that springs will compress about 60-70% for a taut fit.

STEP 5

Once the corners are secured, install remaining anchors 22" from the cover's edge in line with each strap. Make certain the same overlap is maintained as in the corners and that the straps are at a 90 degree, right angle, to the cover's edge. Adhere to right angles, or bulges and/or gaps will occur.

INSTALLING A CUSTOM COVER

PLEASE NOTE: If a cover is going to be anchored into a raised bond beam, spa wall, waterfall, etc., proceed to the instructions on the top of the reverse side.

STEP 1

See Step 1 instructions for "INSTALLING A RECTANGULAR COVER".

STEP 2

Measure exact dimensions of swimming pool and cover. From the difference between these measurements, adjust the overlap so that it is equal at all locations of the pool. Though standard custom cover overlaps are 15"-18", they may vary several inches either way.

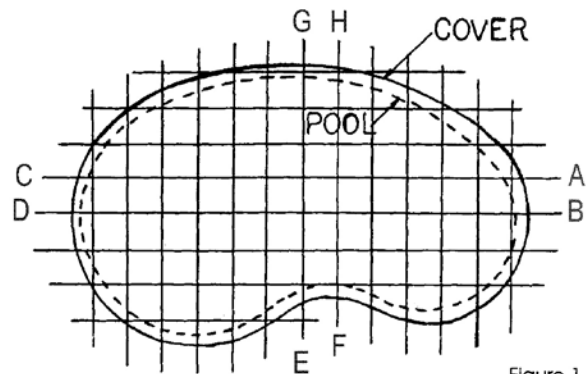

Figure 1

STEP 3

Locate anchor positions on Figure 1. Begin with strap location (A) and measure 22" from cover. Mark this location on the deck. Continue for straps (B), (C), & (D).

STEP 4

Install the anchors for (A), (B), (C) & (D) (see Anchor Installation on inside of directions). Attach flat shaped side of spring to cover straps (see the spring attached to cover for proper spring attachment). Next, install the springs on anchors using the installation rod (see Cover Installation). Adjust the buckles so that springs will compress about 60-70% for a taut fit.

STEP 5

Continue with installing straps and anchors (E), (F), (G) & (H) as indicated in Figure 1.

STEP 6

After completing the initial installation of the first 8 anchors, install the remaining anchors working from the center of the cover to the ends. Remember to alternate sides and to attach and secure each spring to the cover as each anchor is installed.

IMPORTANT: Solid covers must be adjusted after installation to ensure that water does not collect on top of cover. After installation, flood cover with water. If standing water forms puddles that do not drain, simply loosen strap on either side of the drain and tighten straps in the areas with standing water.

RAISED BOND BEAM, SPA WALL, WATERFALL, WALL & ROCK

For raised wall applications, cover must be installed using wall mount anchors. Cover can be attached directly to the eyebolt that is inserted into the wall anchor. However, it is recommended to use the optional cable hardware kit.

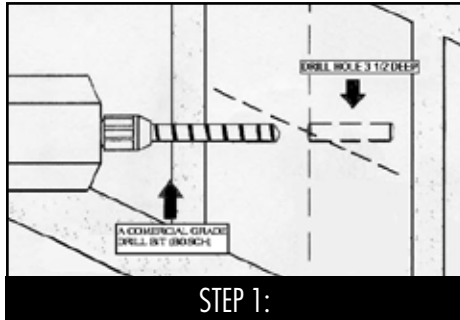

Using a commercial grade 3/8" drill bit, drill a hole 3 1/2" deep into the masonry wall. Clear hole of any debris, hole will be slightly deeper than anchor shaft.

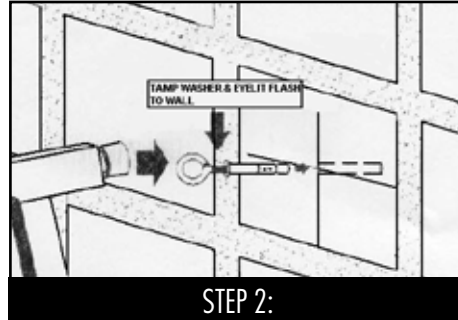

Do not completely screw eyebolt into anchor shaft before tamping. At least 3/4" of thread must be visible. Using hammer or rubber mallet, tamp wall anchor completely into hole, so the casing is flush with the wall.

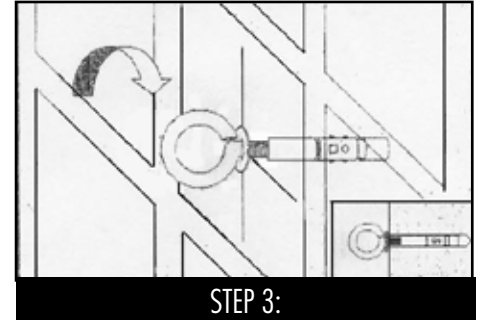

Once the wall anchor is completely tamped in with the eyebolt and flush to the wall, tighten eyebolt into wall anchor using a screw driver or rod thru the eyelet to ensure the tightest possible fit.

OPTIONAL CABLE INSTALLATION

- Install a standard cement anchor at each end of the raised wall. These anchors will be used to attach both ends of the cable.
- Locate wall anchor positions. To ensure cover is level, install wall anchors at the same level as the deck. Wall anchors should be installed approximately every 3' on straight walls and approximately every 18" on tight radius walls.
- Install wall anchors per instructions above.
- Create a loop on one end of the cable using two cable clamps. Loop must be large enough to fit over cement anchor.
- Hook looped end of cable on one of the anchors that was installed in Step 1 above and run cable through eyebolts to opposite end.
- Attach turnbuckle to other end of the cable using the remaining clamps.
- Hook open end of the loosened turnbuckle to the second anchor that was installed in Step 1 on the opposite end.
- Tighten turnbuckle so cable is taut. Note: Eyebolts should be screwed all the way into the wall anchor so the cable is as close to the wall as possible. Proper installation requires that gap between cover and wall must not exceed 4".
- Next, position the cover on the pool to begin installation. Cover should be attached to cable area first. Fasten snap hooks on the underside of the cover to the cable.
- Adjust cover so it is flush with the wall and overlaps the pool evenly on all unobstructed sides.
- Mark and install anchor locations on the opposite side of the pool from the raised wall. Install those cross straps and ensure they are straight and tight.
- Continue installing cover using Custom Cover installation instructions on page 1.

WOOD ANCHOR INSTALLATION

STEP 1
Install wood anchor by drilling a 1 1/2" diameter hole to depth of 1/8" with a wing bit.

STEP 2
Drill a 3/4" diameter hole in the center of the wing bit hole to a final depth of 1 1/4".

STEP 3
Continue with cover installation on front page.

WOOD DECK ANCHOR

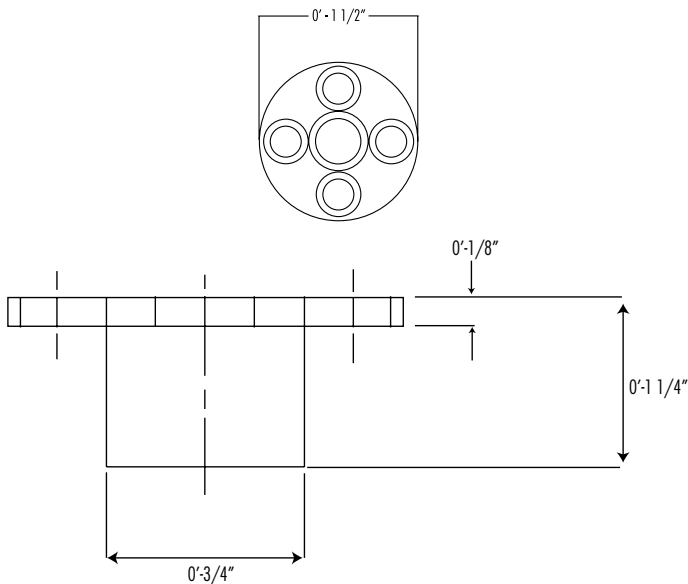

ANCHOR INSTALLATION

STEP 1
Install brass anchors by drilling 3/4" diameter holes to a depth of 2". Bevel or ream the top of the hole for flush fit.

Remove anchor screw from casing. Spray anchor, screw casing and aluminum tamping tool with silicone.

STEP 2
Insert tamping tool and tap the retainer into place. Then insert the anchor screw using the hex key.

BRASS ANCHOR

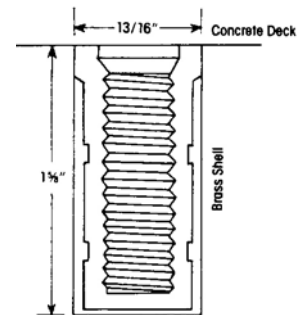

COVER INSTALLATION

Insert the installation rod through rounded end of spring. (Diagram A)

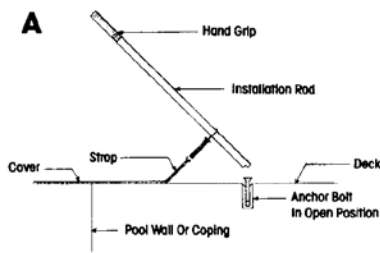

Place heel of rod behind raised anchor. Slip spring over anchor by moving handle away from the pool wall. Step down on spring. Remove installation rod by rotating 180 degrees and cover is then installed. (Diagram B)

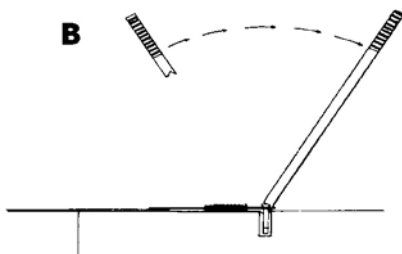

COVER REMOVAL

Insert installation rod over anchor with notch away from pool. (Diagram C) Next, press down and rotate 180 degrees. Heel of rod will force spring free of anchor. Tilt rod to release spring (Diagram D)

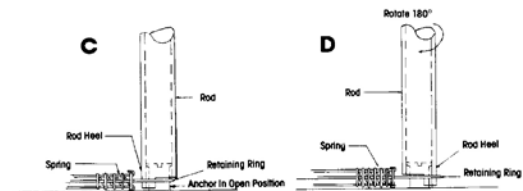

CUSTOM DECK INSTALLATIONS

LOOSE BRICK, STONE OR LAWN AND WOOD DECK ONLY IF WOOD DECK IS LESS THAN 1" THICK.

METHOD 1

Insert the brass anchor casing into 3/4" ID pipe or conduit which is driven at least 15" into the ground. We highly recommend the use of the GLI Pool Products lawn tube. The GLI lawn tube is specifically designed to accept the brass anchor casing.

STEP 1

Locate anchor positions as usual.

STEP 2

Drill a hole in the wood deck, loose brick or stone large enough for a snug fit with the chosen lawn tube.

STEP 3

Tap anchor casing with aluminum tamping tool into the pipe until it is flush with the pipe.

STEP 4

Drive the pipe through the deck surface with a wood block if possible, until pipe is flush with the deck surface. If there is a space between wood deck and the ground, the pipe must be lengthened so that a minimum of 15" is driven into the ground.

METHOD 2

The factory tent stake may be used at times in loose brick, stone, lawns and planters. The tent stake will not hold adequately in loose soil. Please note: Method 1 is safer and should be used without exception when more than three (3) stakes are necessary in succession.

(Cover must be installed tautly. Loose-fitting covers can cause excessive abrasion which is not covered by warranty.)

CARE AND MAINTENANCE

- The springs should be very taut upon initial installation. In time, the cover will relax and the tension will ease.
- The cover is designed to screen out leaves and other debris. Clear water can only be maintained if proper levels of chlorine and algaecide are maintained.
- Be sure not to drop the pool's water level more than 18" from top of pool during winter months. Failure to do so will place undue strain on the cover and void the warranty.
- Debris may be easily hosed off a properly installed cover.
- Removal and subsequent installation is made easier if the cover is fan-folded.
- Store the cover in the mesh storage bag included. Hang the bag off the floor so the cover can drain.
- Flush out anchor casings with a hose several times a year to prevent sticking. Spray anchor and casing with silicone.
- For solid cover owners: To clean the debris screen, remove cover, open and fold back the mesh panel on top of the cover. Hose the filter screen off from behind to remove fine debris. Close panel and store.
- FOR SOLID COVERS: Cover must be suspended above the pool's water level in order to drain. Excessive melting snow and spring rain can raise the pool's water level too high for cover to drain. If this occurs, simply drain some water from the pool until the cover is suspended above the pool's water level. Be sure not to drop the pool's water level more than 18" from the top of pool. Straps and springs may need tightened to achieve proper tension.